

6年以下女子シングルス（6GS）

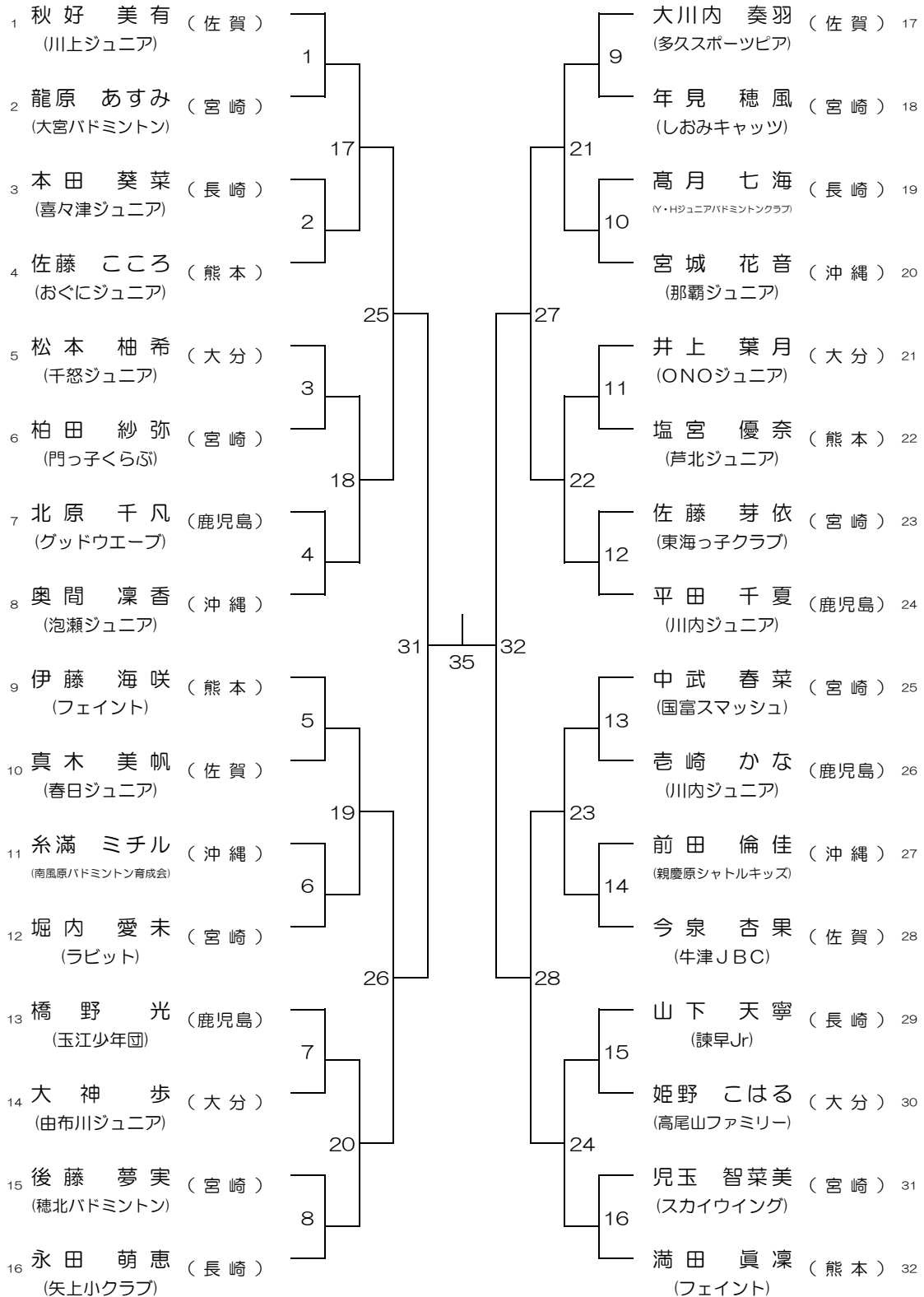

3・4位決定戦

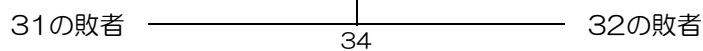

5位決定戦

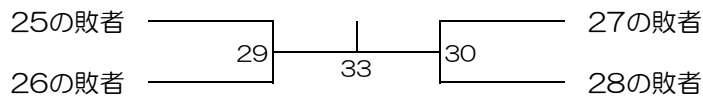

5年以下女子シングルス (5GS)

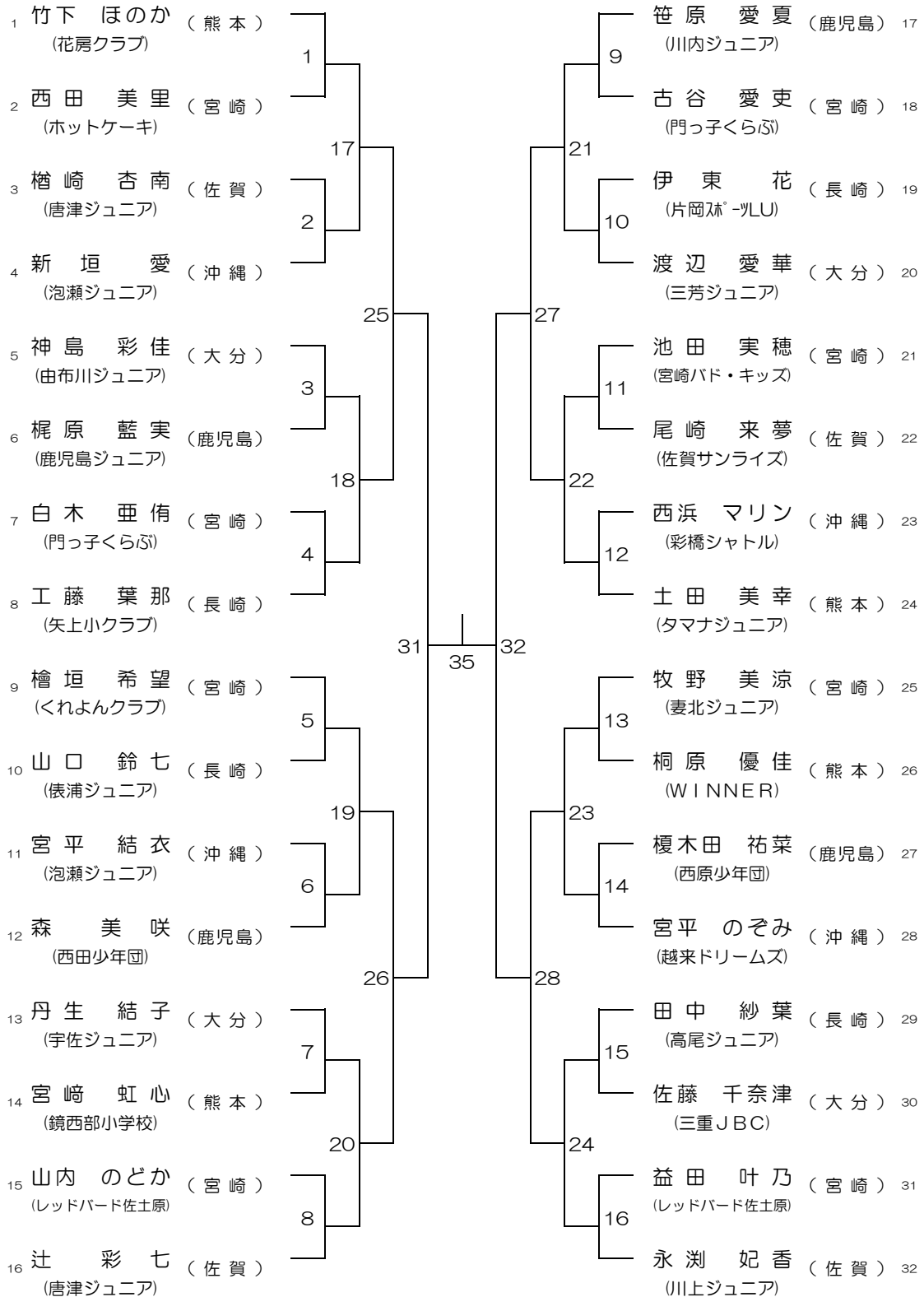

3・4位決定戦

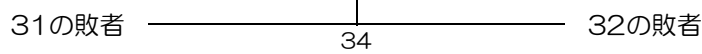

5位決定戦

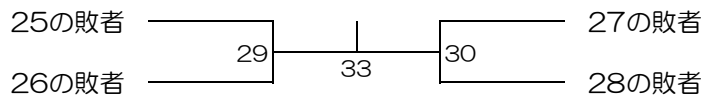

4年以下女子シングルス（4GS）

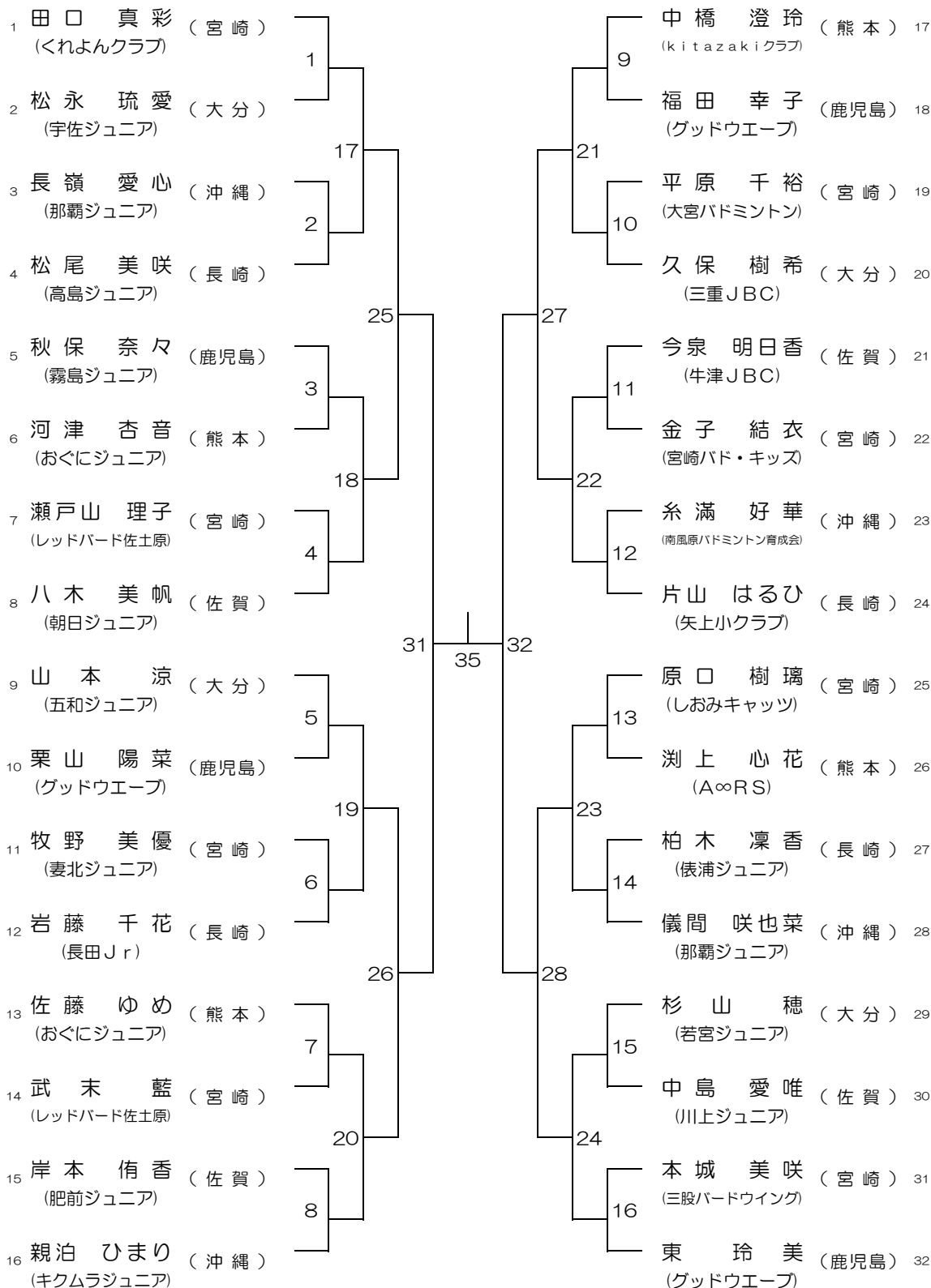

3・4位決定戦

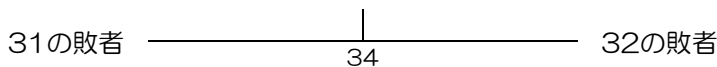

5位決定戦



6年以下女子ダブルス (6GD)

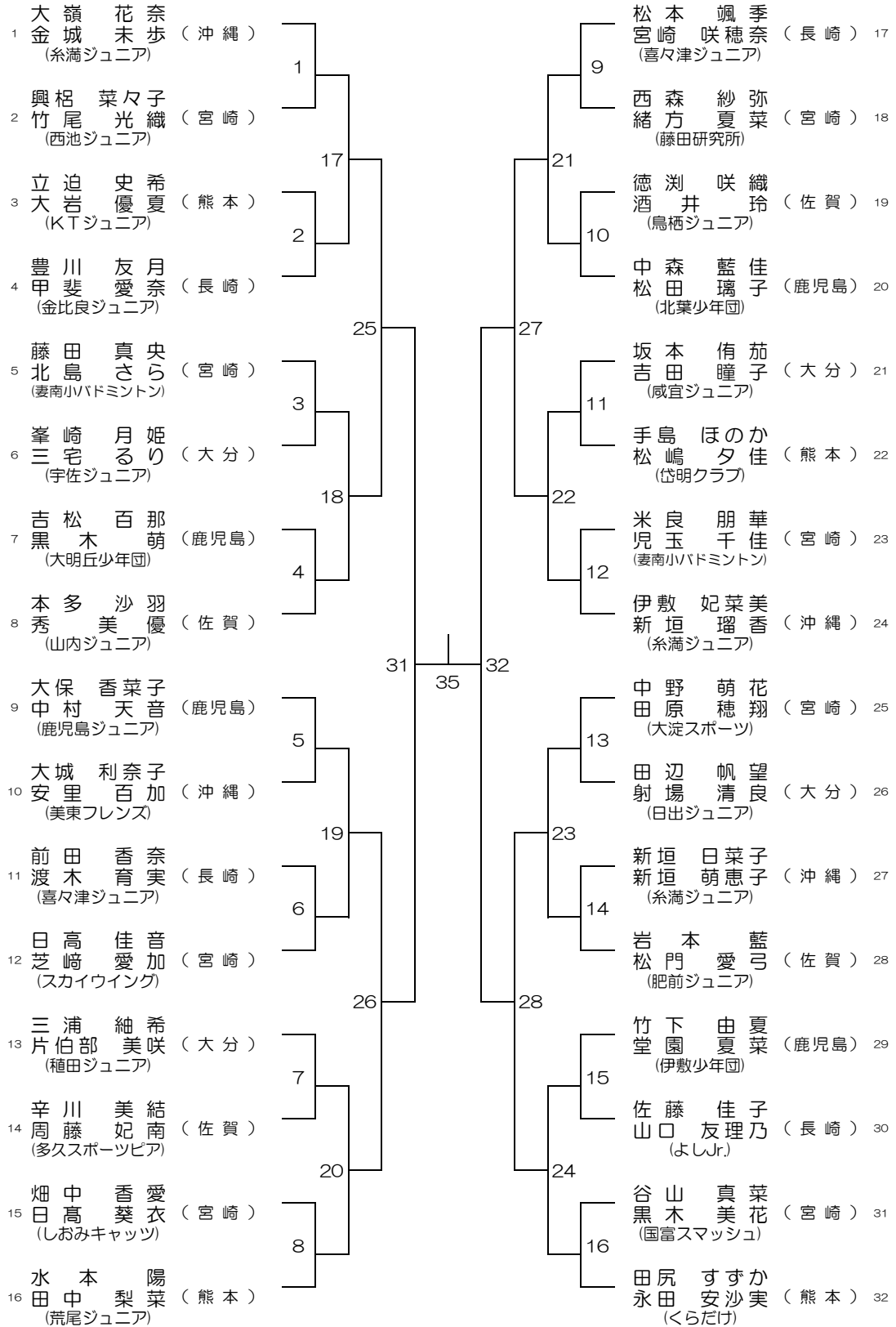

3・4位決定戦

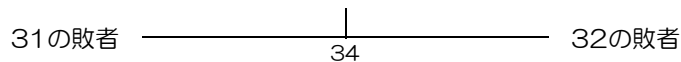

5位決定戦

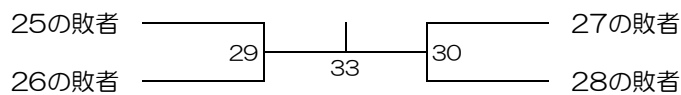

5年以下女子ダブルス (5GD)

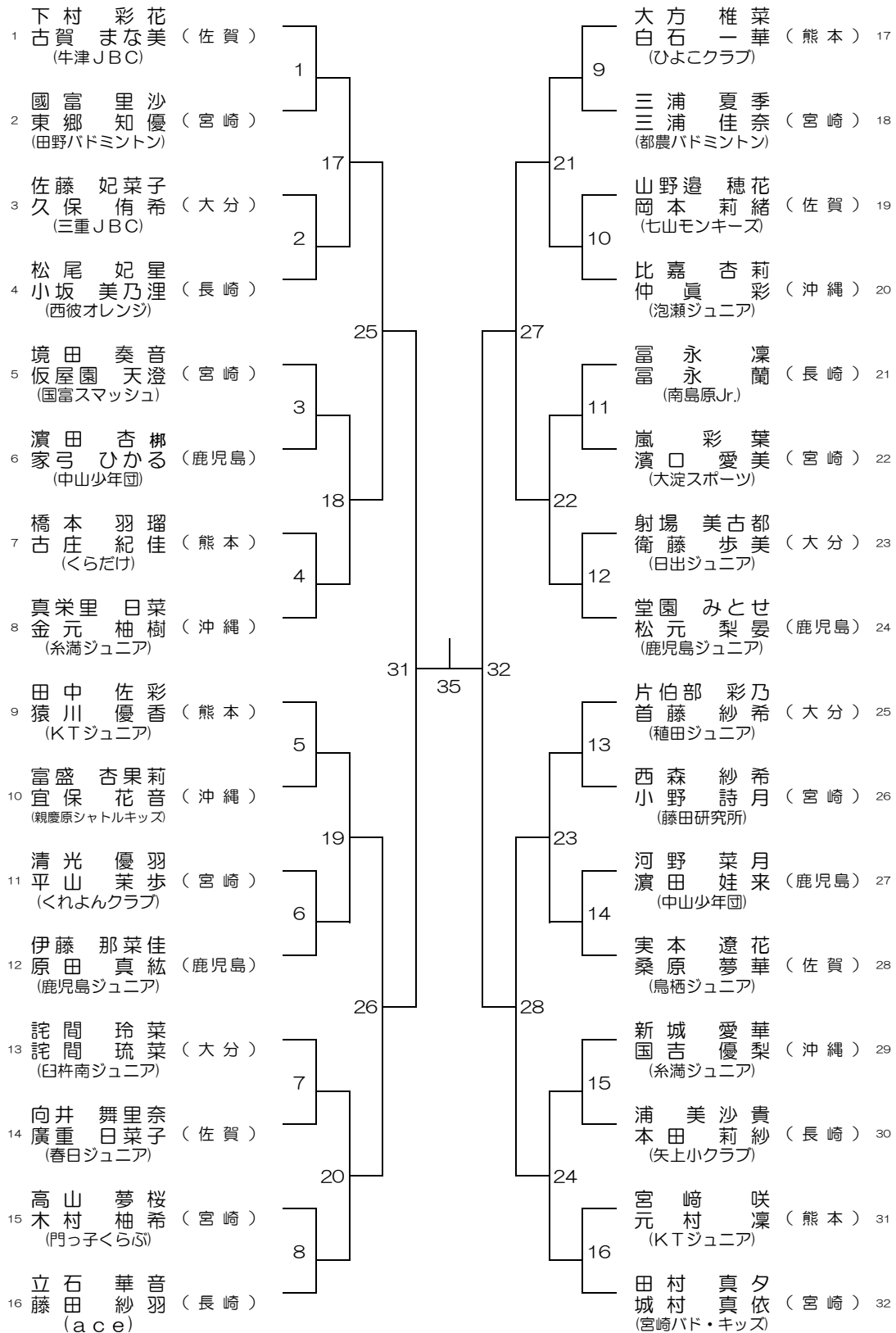

3・4位決定戦



5位決定戦

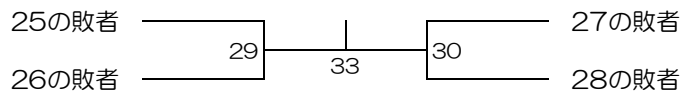

4年以下女子ダブルス (4GD)

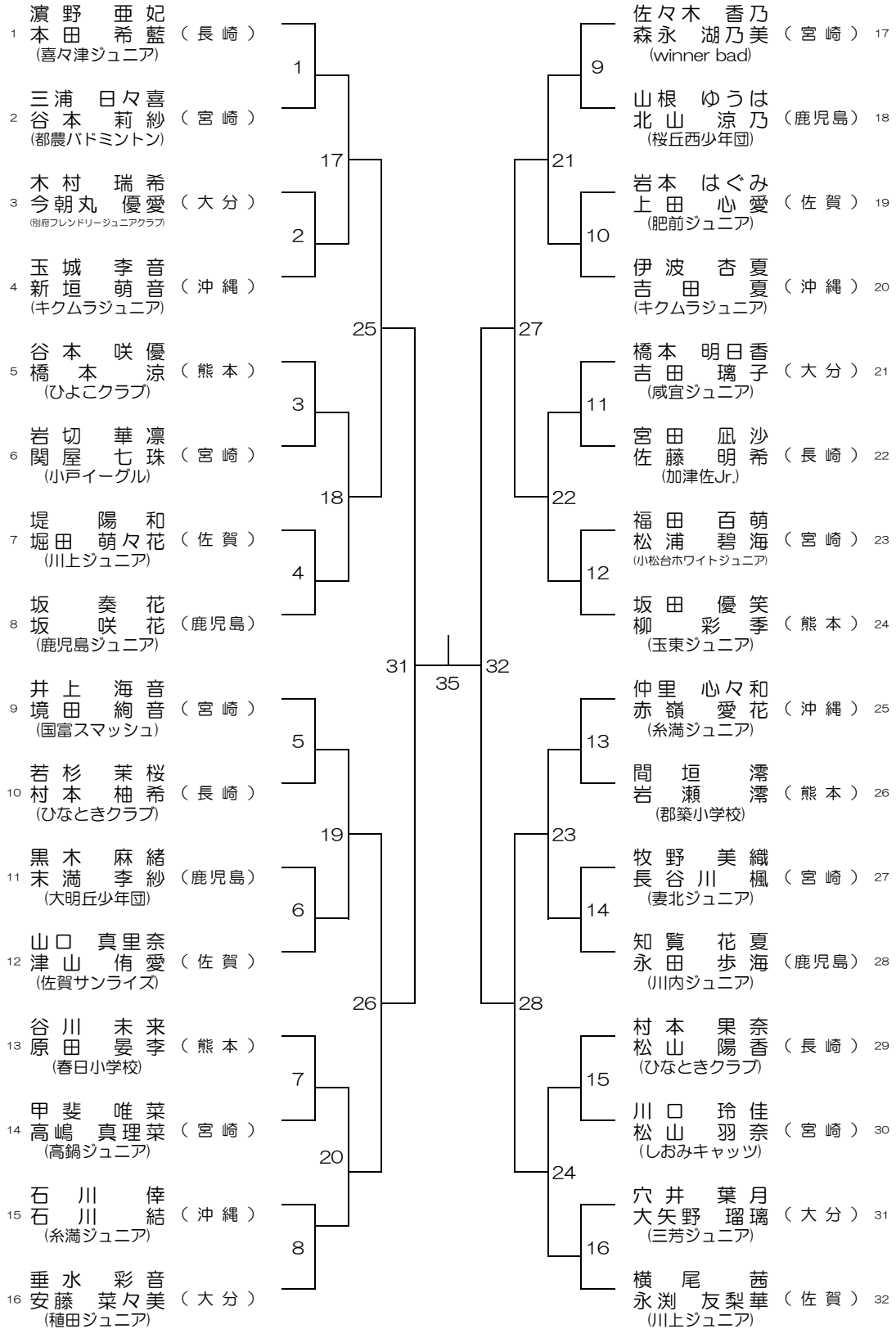

3・4位決定戦

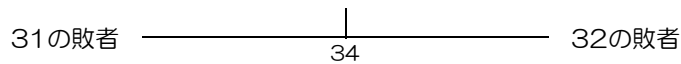

5位決定戦

