

新人C(NC)

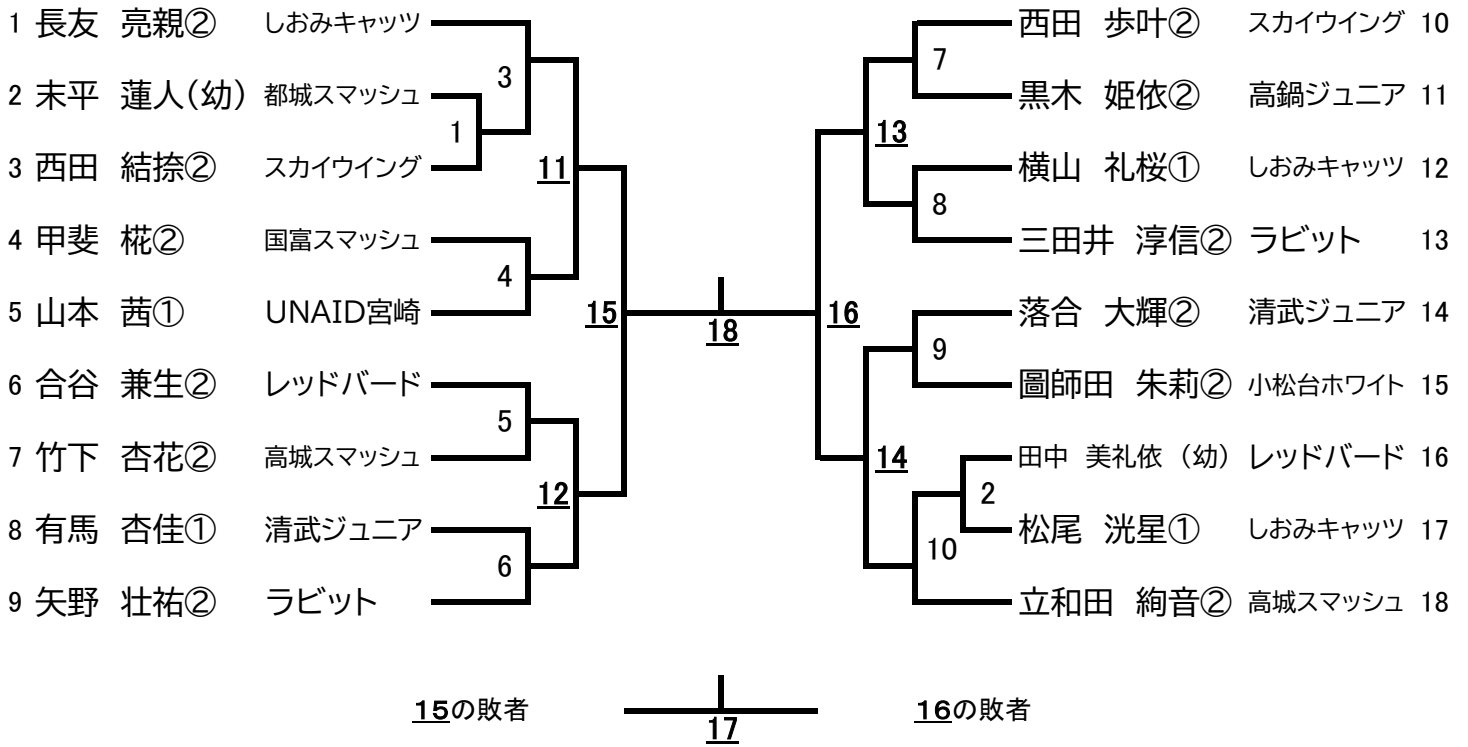

新人B(NA)

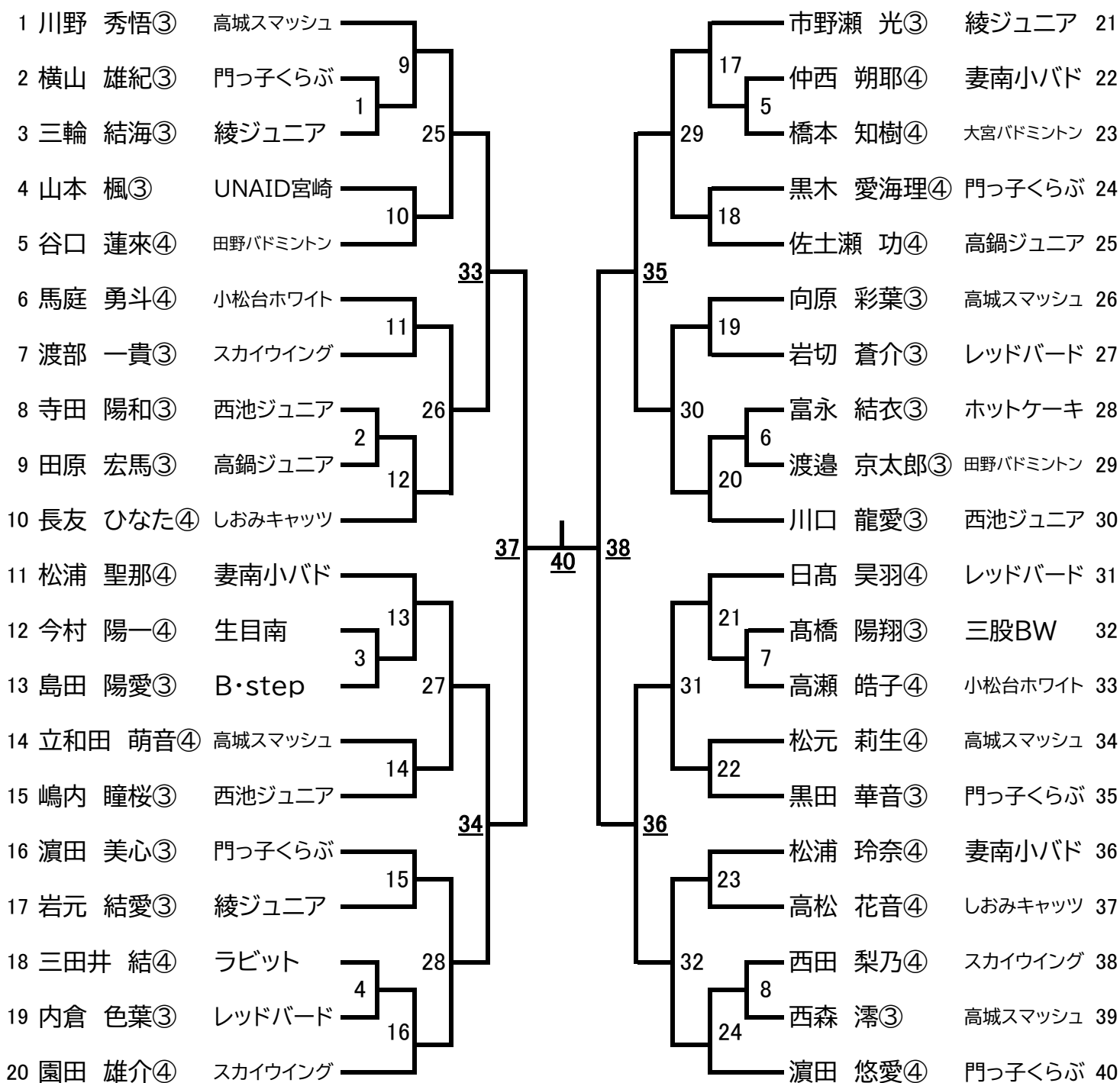

37の敗者

39

38の敗者

女子C(GC)

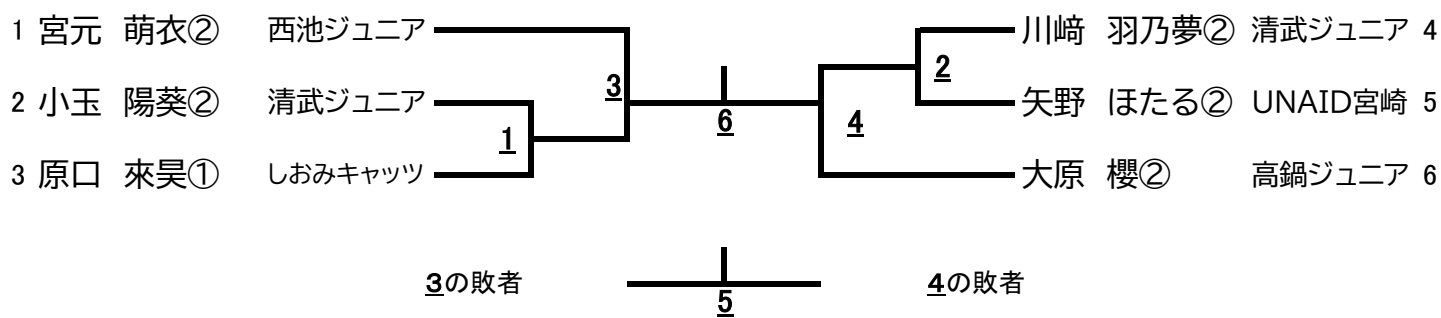

女子B(GB)

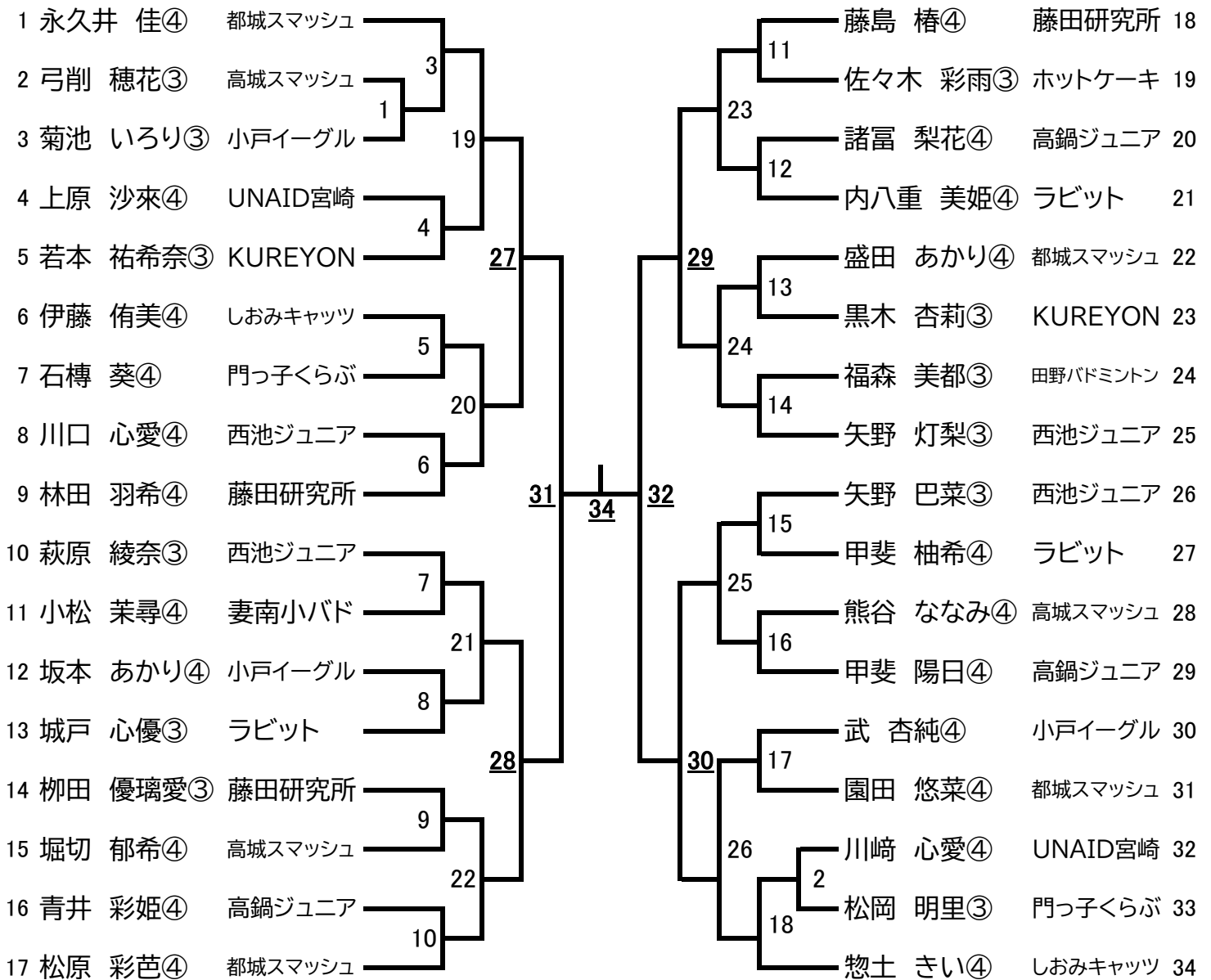

31の敗者

33

32の敗者

女子A(GA)

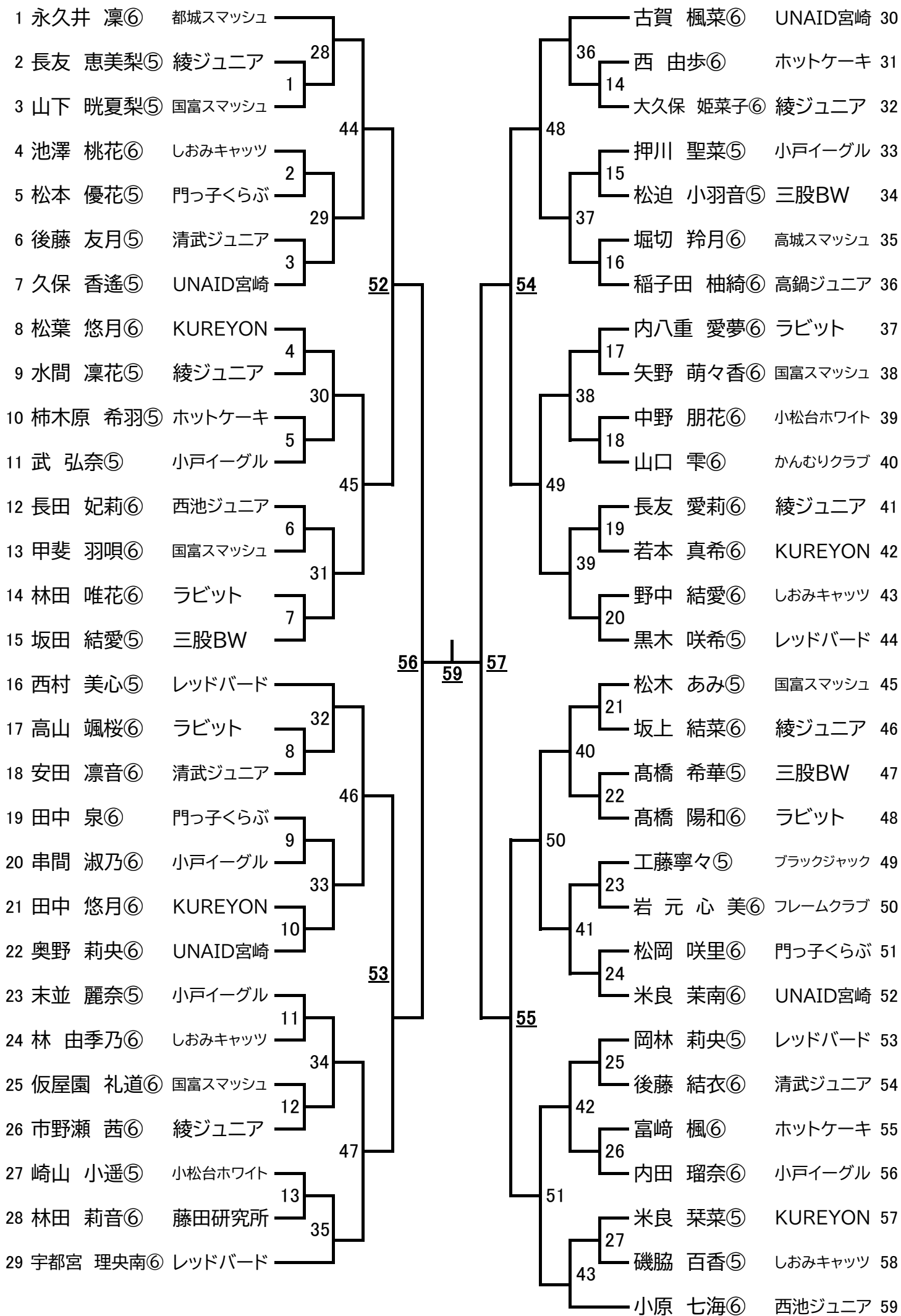

56の敗者

58

57の敗者

男子C(BA)

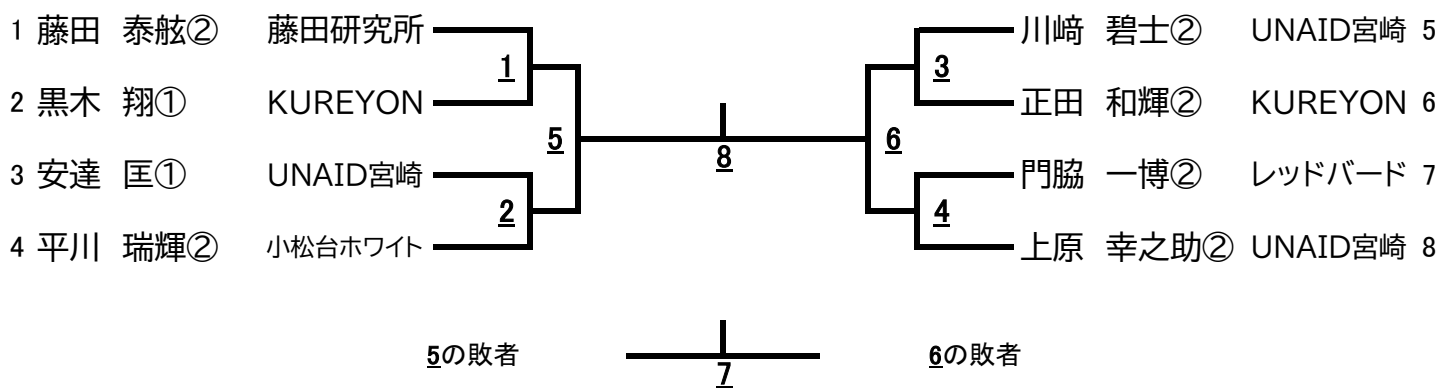

男子B(BA)

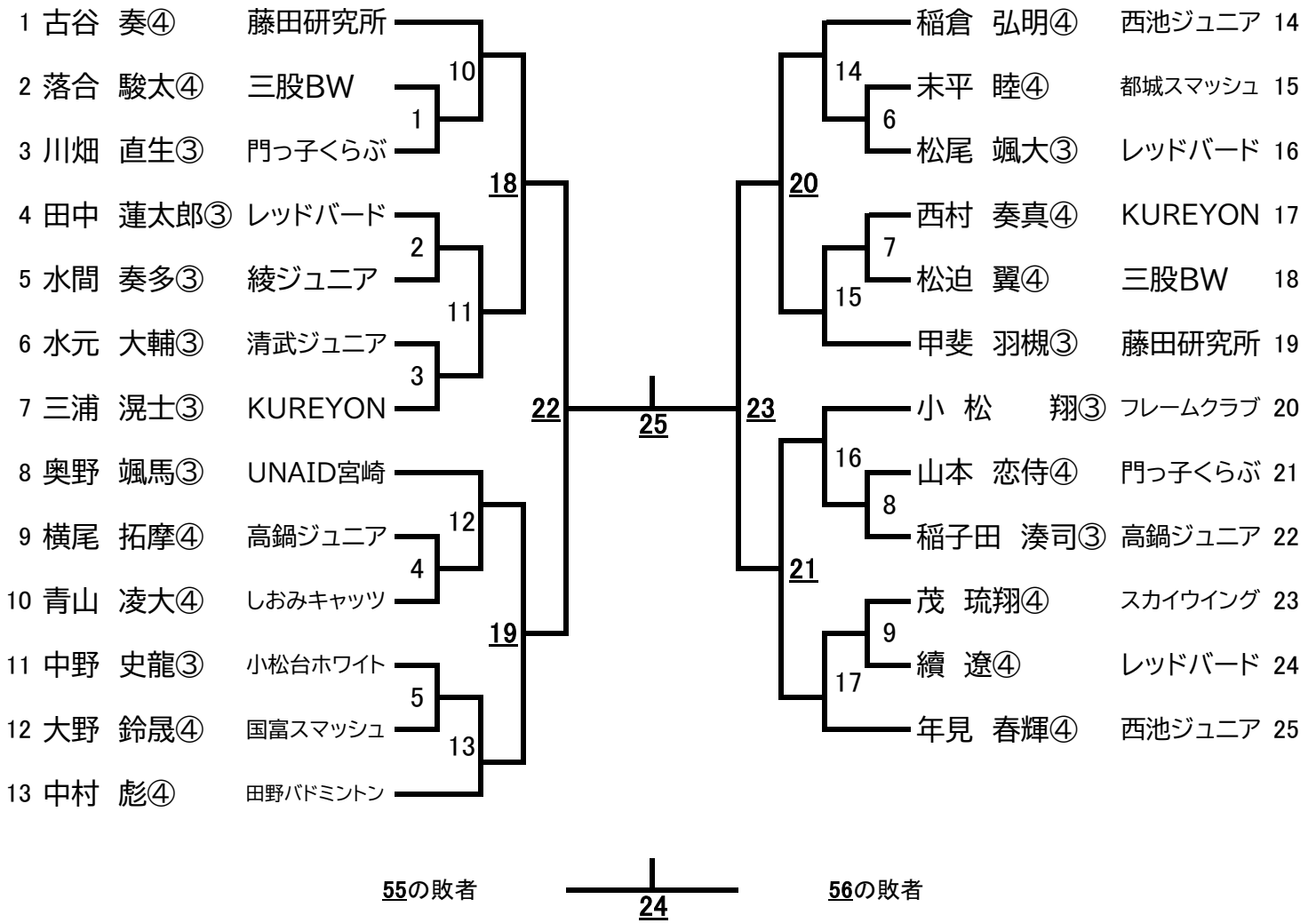

男子A(BA)

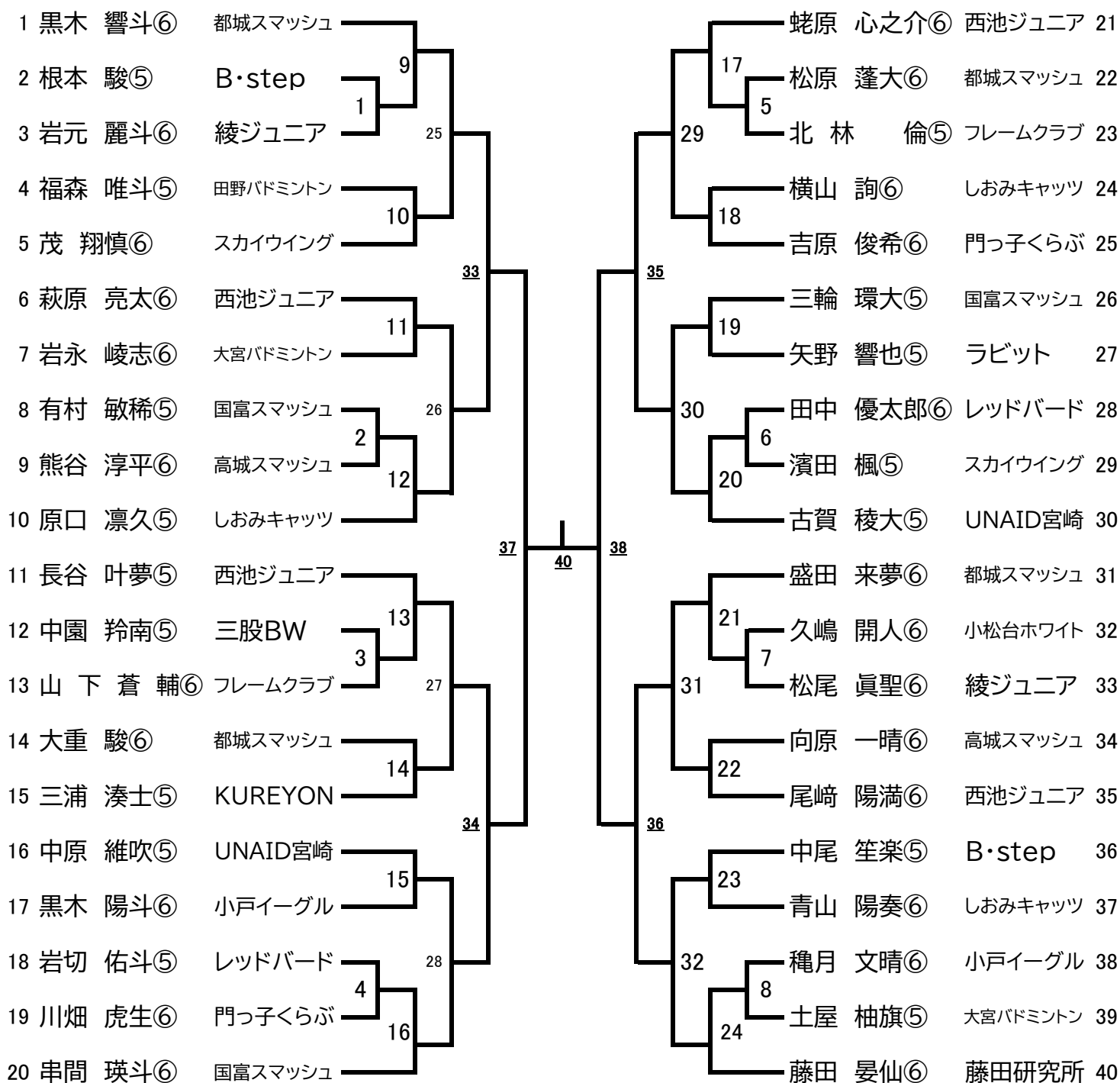

37の敗者

39

38の敗者